

Owner's Guide

Model S-38E

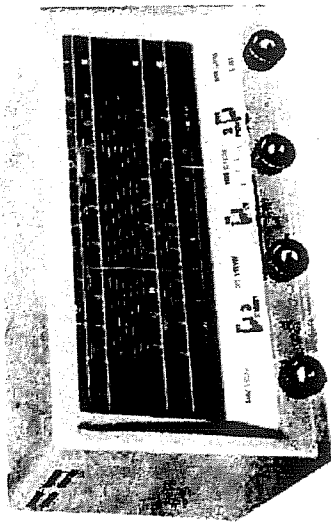

GENERAL DESCRIPTION

Your new Hallicrafters Receiver-tunes from 540 kilocycles to 31 megacycles to bring you the finest in world-wide radio reception. You'll hear foreign and domestic shortwave broadcasts, amateurs, police, aircraft, ships, and countless other exciting distant stations... as well as all your favorite programs on standard broadcast. The receiver employs the latest type superheterodyne circuit and provides for reception of AM (voice) and CW (code) signals over its entire tuning range. Special features in your receiver include an electrical band-spread dial for fine tuning of the amateur and shortwave bands, a powerful built-in Alnico V permanent magnet speaker, provisions for headphone operation, and a receive-standby switch on the front panel that permits you to silence the receiver without turning it off. Your receiver has an unusually high degree of sensitivity necessary to receive weak and distant stations. Careless operation may result in excess noise or background hiss. These undesirable effects can be held to a minimum by careful adjustment of the tuning controls as well as the proper selection and arrangement of the antenna.

POWER SOURCE

The receiver is designed to operate on 105 to 125 volt 50/60 cycle, AC, or DC current. It may also be operated on 210 to 250 volt AC/DC current by using Line Cord Adapter 087-401568, available as an accessory from your Hallicrafters dealer. Power consumption is 30 watts.

HEADPHONES

Connections are provided at the rear of the receiver for connecting headphones. Any commercial headphones ranging from 80 to 10,000 ohms may be used. For headphone operation, set the Speaker-Phones selector switch at "Phones".

the hallicrafters co.

MANUFACTURER OF RADIO TELEVISION AND ELECTRONIC EQUIPMENT, CHICAGO 24, ILL.



TEL: 616-5

SERVICE OR OPERATING QUESTIONS—For any further information regarding operation or servicing of your radio, contact your Hallicrafters dealer. The Hallicrafters Co. maintains an extensive system of authorized service centers where any required service will be performed promptly and efficiently at a nominal charge. All Hallicrafters Authorized Service Centers display the sign shown at the right. For the location of the one nearest you, consult your dealer or telephone directory.

Warranty

"The Hallicrafters Company warrants each new radio product manufactured by it to be free from defective material and workmanship and agrees to remedy any such defect or to furnish a new part in exchange for any part of its manufacture which under normal installation, use and service discloses such defect, provided the unit is delivered by the owner to our authorized radio dealer, wholesaler, from whom purchased, or, authorized service center, intact, for examination, with all transportation charges prepaid within ninety days from the date of sale to original purchaser and provided that such examination discloses in our judgment that it is thus defective.

This warranty does not extend to any of our radio products which have been subjected to mis-use, neglect, accident, shock, fire, flood, or other causes, or to units which have been repaired or altered outside of our factory or authorized service centers, nor in cases where the serial number thereof has been removed, defaced or changed, nor to accessories used therewith not of our own manufacture.

Any part of a unit approved for remedy or exchange hereunder will be remedied or exchanged by the authorized radio dealer or wholesaler without charge to the owner.

This warranty is in lieu of all other warranties expressed or implied and no representative or person is authorized to assume for us any other liability in connection with the sale of our radio products.

the Hallicrafters co.

943622

the hallicrafters co.

4401 WEST 5TH AVENUE

Chicago 24, Ill.

ANTENNAS

The receiver is designed to operate from either a single-wire antenna, or a half-wave doublet or other tuned antenna. Antenna connections are made to a three terminal strip at the rear of the receiver marked "A1", "A2", and "G".

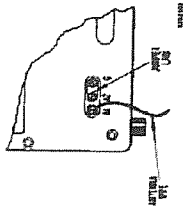

Fig. 2. Single-Wire Antenna

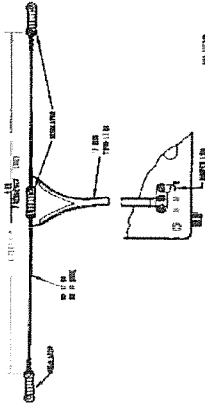

Fig. 3. Doublet Antenna Using Twin-Lead Transmission Line

SINGLE-WIRE ANTENNA

The simplest antenna and one which will provide satisfactory performance throughout the entire tuning range is a conventional single-wire antenna. In most localities, satisfactory results can be obtained with just the 15-foot antenna wire included with the receiver. It is simply necessary to attach one end of this wire to terminal "A1", connect the jumper link between "A2" and "G", and then run the wire about the room in any convenient manner. (See Fig. 2) If the receiver is operated in a steel constricted building or where receiving conditions are exceptionally poor, an outside antenna 50 to 100 feet long may be necessary. In some locations, reception may be improved by connecting a ground wire (ordinary copper wire) from terminal "G" to a cold water pipe or outside ground rod. While the use of an outside ground rod installed in accordance with Insurance Underwriter's Laboratories requirements is adequate protection against lightning, we strongly recommend an additional connection to the nearest cold water pipe to eliminate any shock hazard.

HALF-WAVE DOUBLET ANTENNA

For top performance, especially on the shortwave and amateur bands, the use of a half-wave doublet or other type of antenna employing a 52 to 600 ohm transmission line is recommended. A typical doublet antenna installation is shown in Fig. 3. The doublet antenna should be cut to the proper length for the most used frequency or band of frequencies. The overall length in feet of a doublet antenna is determined by the following formula:

$$\text{Length in feet} = \frac{498}{\text{Frequency in megacycles}}$$

For maximum signal pickup, the doublet antenna should be erected with its length at right angles to the desired station. When a transmission line such as "Whithead" or a twisted pair is used, the transmission line connects to terminals "A1" and "A2", and the jumper link between "A2" and "G" is disconnected. The doublet antenna provides optimum performance only at the frequency for which it is cut. Therefore, it may be desirable for reception on frequencies remote from the antenna frequency to utilize the antenna as a single wire type. This is accomplished by connecting the two transmission line leads together and connecting them to terminal "A1". The jumper link in this case should be connected between terminals "A2" and "G".

TUNING DIAL

The top dial scale is the standard broadcast band. To convert the readings on this band to kilocycles simply add one zero. For example, 70 on the dial is 700 kilocycles. The shortwave bands are marked 2, 3, and 4. The readings on these bands are in megacycles. The standard broadcast band is marked with a "CD" emblem and a dot at 640 and 1240 kilocycles to indicate the two official civil defense frequencies. In a civil defense emergency, tune to either of these two frequencies for official civil defense news, instructions, and information.

RECEIVE-STANDBY SWITCH

This switch is normally set at "Receive". When set at "Standby", the receiver is silenced but the tubes remain at operating temperature for instant use. To resume reception at any time, simply return the switch to "Receive" position.

AM-CW SWITCH

Set this switch at "AM" to listen to voice or musical broadcasts. Set it at "CW" only if you wish to hear code signals.

BAND SELECTOR CONTROL

Set this control for the band you wish to tune. The four positions of this control correspond to the band numbers at the left side of the dial.

OFF-VOLUME CONTROL

Turn this control clockwise to turn the receiver on and to increase volume. Allow about one minute for the tubes to warm up. When operating on DC (direct current), reverse the power plug in the wall outlet if the receiver does not operate after the one minute warm up, as the receiver will operate ONLY with the plug in one position. When operating on AC (alternating current), try reversing the power plug for minimum hum after the receiver is in operation. To turn the receiver off, simply rotate the Off-Volume control fully counterclockwise, until a click is heard.

TUNING AND BANDSPREAD CONTROLS

Wide tuning is performed with the Tuning control and fine tuning with the Bandspread control. To tune the receiver, set the Bandspread dial pointer at "O" and then slowly turn the Tuning control to the desired station. When trying to locate weak distant stations, it is suggested that the Off-Volume control be initially set near maximum and then readjusted for the desired level after the station has been tuned in. For CW (code) reception, adjust the Tuning control for the desired pitch when tuning in the station. The dial readings will correspond to the station frequencies only if the Bandspread dial pointer is set at "O".

The Bandspread control is an electrical fine tuning adjustment which permits you to accurately tune in stations on crowded bands by spreading them out. It may be used in two different ways. The first method of tuning is used when it is desired to tune in a single signal with precision accuracy. The Bandspread dial pointer is set at about "5", then the signal is located with the Tuning control, and finally the signal is accurately tuned in by "rocking" the Bandspread control (turning it a few degrees to the left and right) until the signal is loudest and clearest. The second method of tuning is used when it is desired to tune through a range of frequencies, such as the amateur bands. Set the Bandspread dial pointer at "O", set the Tuning control for the high end of the selected band or range of frequencies, and then tune through the range with the Bandspread control. Turning the Bandspread control from "O" to "100" tunes the receiver progressively lower in frequency.

SERVICE DATA

Model S-38E

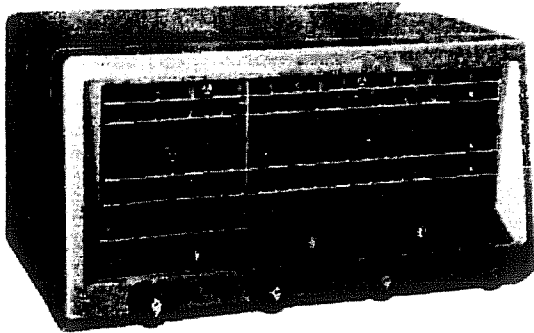

Fig. 1. Hallicrafters Model S-38E

TECHNICAL SPECIFICATIONS

TUBES Five including rectifier
 SPEAKER 5-inch PM; 3.2-ohm voice coil
 HEADPHONE OUTPUT 15 ohms

ANTENNA INPUT ... For single wire or 52-600 ohm
 balanced or unbalanced line
 POWER SOURCE . 105-125 volts DC or 50/60 cycles AC
 POWER CONSUMPTION 30 watts
 RECEPTION AM and CW
 INTERMEDIATE FREQUENCY 455 KC
 WEIGHT Net-12 lb., Shipping-14 lb.
 DIMENSIONS 12-7/8" x 7" x 9" deep

TUBE AND DIAL LAMP REPLACEMENT

The dial lamp and tubes are accessible for replacement by removing the cabinet. For types used, refer to Page 4.

CAUTION: Before attempting to make any replacement, rotate the Bandspread control fully clockwise and the Tuning control fully counterclockwise to prevent damage to the tuning gang.

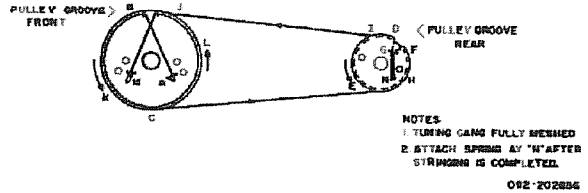

Fig. 2. Main Tuning Gang Drive Stringing Diagram

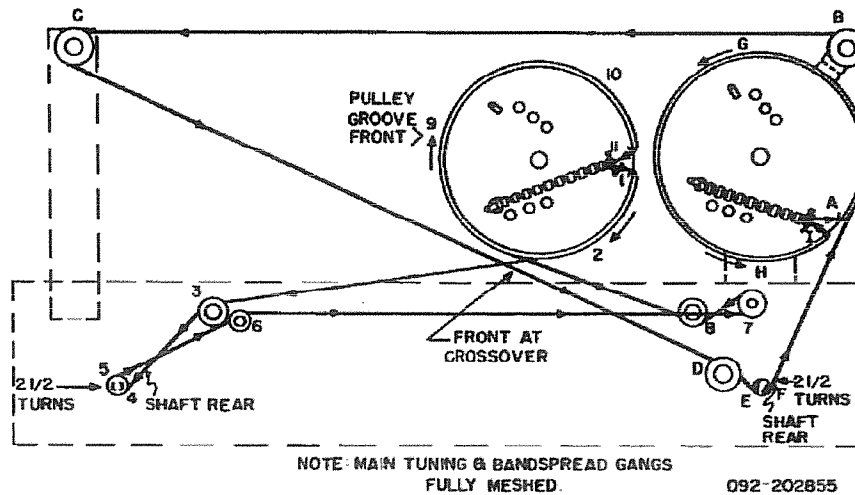
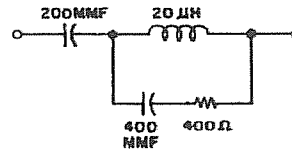

Fig. 3. Main Tuning and Bandspread Gang Pointer Drive Stringing Diagrams

the hallicrafters co.
 2481 W. FIFTH AVENUE • CHICAGO 24, ILLINOIS

ALIGNMENT PROCEDURE

- Use an amplitude modulated generator covering 455 KC to 30 MC.
- Use a modulated output for every step except Step 2.
- Connect output meter across speaker voice coil.
- Use a non-metallic alignment tool.
- Standard RETMA dummy antenna as shown in Fig. 4.
- Set the AM/CW switch at AM, (except for BFO adjustment), SPEAKER/PHONES switch at SPEAKER, VOLUME control at maximum. RECEIVE/STANDBY switch at RECEIVE and the BAND SPREAD control at 0.



092-01549

Fig. 4. RETMA Dummy Antenna

Step	Signal Generator Connections	Generator Frequency	Band Selector Setting	Receiver Dial Setting	Adjust
IF ALIGNMENT					
1	High side thru a .01 mfd. capacitor to stator plates of front section of TUNING gang. Low side to chassis.	455 KC	1	1.0 MC	A, B, C and D for maximum output. Keep reducing gen. output so that the reading on the output meter does not exceed 50 milliwatts.
BFO ADJUSTMENT					
*2	Same as Step 1.	455 KC (No Mod.)	1	1.0 MC	Set the AM/CW switch at CW. For correct BFO operation, vary the coupling between lead E and pins 1 and 5 of 12BA6 (V2) for a nominal beat note. Phasing lead E toward pin 1 increases the strength of the beat.
RF ALIGNMENT					
3	Highside thru RETMA antenna to terminal A1 on back of chassis. Low side to chassis. Connect jumper between A2 and G.	30 MC	4	30 MC	F and G for maximum output as in Step 1.
4	Same as Step 3.	14 MC	3	14 MC	H and J for maximum output as in Step 1.
5	Same as Step 3.	5 MC	2	5 MC	K and L for maximum output as in Step 1.
6	Same as Step 3.	1500 KC	1	1.5 MC	M and N for maximum output as in Step 1.
		600 KC	1	.6 MC	P for maximum output as in Step 1.

* Step 2 is usually unnecessary. Adjustment should be made ONLY if a weak beat note is obtained on strong CW signals indicating lack of coupling between wire lead E and pins 1 and 5 of 12BA6.

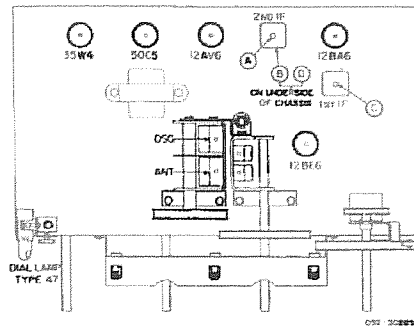

Fig. 5. Top View of Chassis

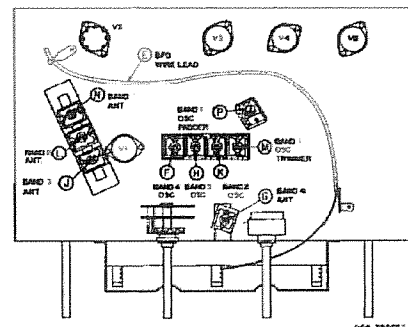
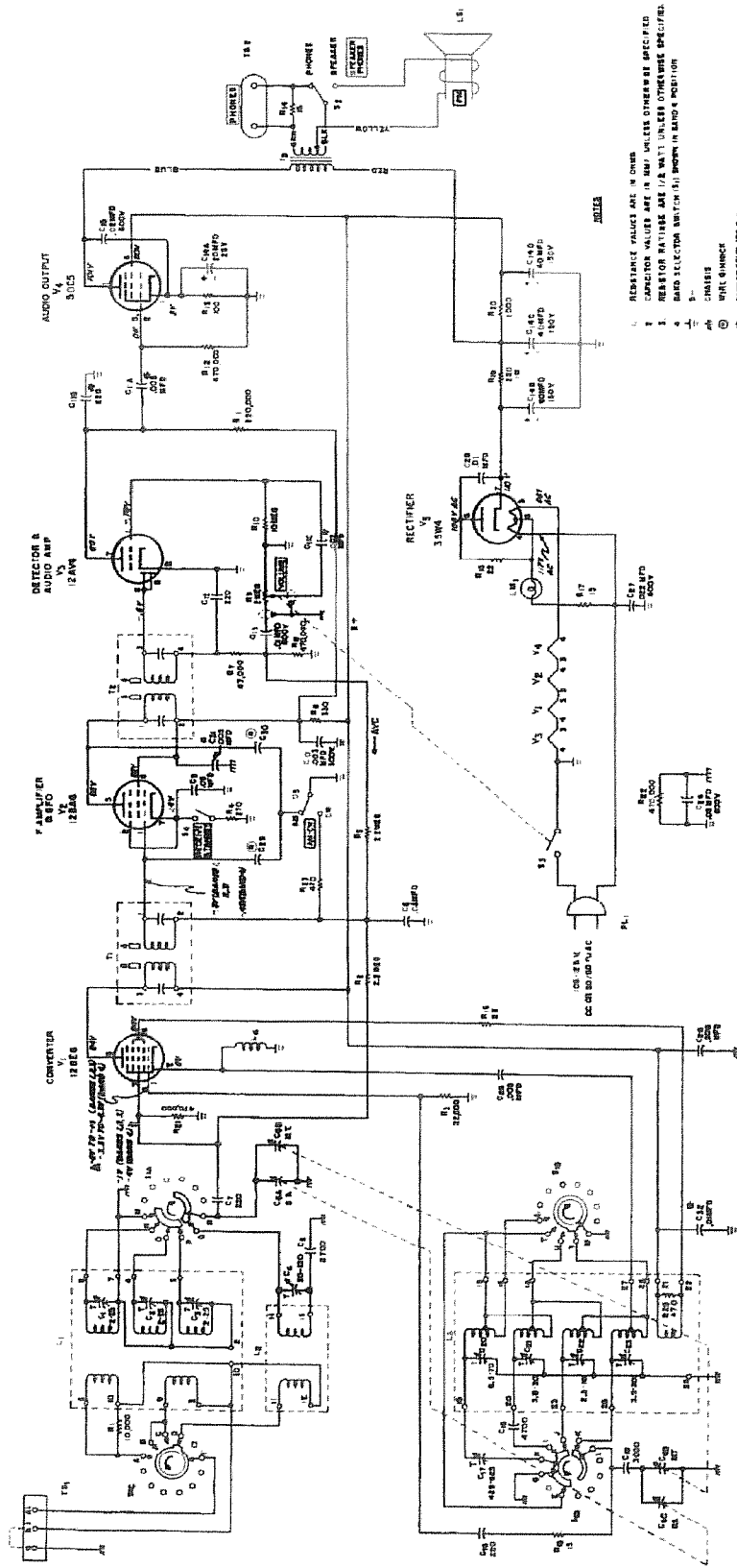
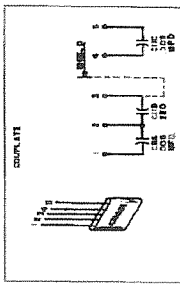

Fig. 6. Bottom View of Chassis



- REPLACEMENT VALUES ARE IN POUNDS
 CAPACITOR VALUES ARE IN MICRO FARADS UNLESS OTHERWISE SPECIFIED
 RESISTOR VALUES ARE IN OHMS UNLESS OTHERWISE SPECIFIED
 BAND SELECTOR SWITCH (S1) SHOWN IN BAND 4 POSITION
- 1. RESISTOR
 - 2. CAPACITOR
 - 3. COIL
 - 4. SWITCH
 - 5. SOCKET
 - 6. TUNING INDICATOR
 - 7. PART OF COMPLETE SET



- ALL VOLTAGES ARE MEASURED BETWEEN THE SOCKET TERMINALS AND B-
 POINT OF GRAY 1, WITH ANTENNA TERMINALS SHORTED AND/OR SWITCH AT
 BAND 4 POSITION, UNLESS OTHERWISE SPECIFIED
 ALL VOLTAGES ARE MEASURED WITH A MEDIUM RANGE VOLTMETER (VOM) AND ARE
 DC AND POSITIVE UNLESS OTHERWISE SPECIFIED
 VALUES WITH TUNING GANG SETTING

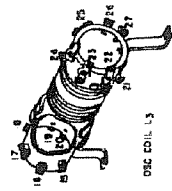

NOTE: VALUES TO BE REPLACED SHOWN ARE ORIGINAL AND VALUES NOT BE FOUND
 IT IS RECOMMENDED THAT THE VALUES OF ANY REPLACEMENT COMPONENTS
 TO THE ORIGINAL VALUE OF THE PART BEING REPLACED

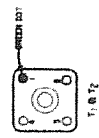
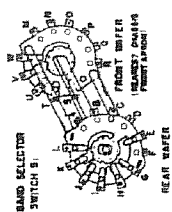
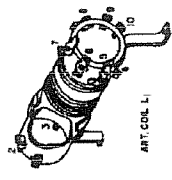
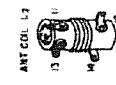

SERVICE PARTS LIST

Schematic Symbol	Description	Hallcrafters Part Number	Schematic Symbol	Description	Hallcrafters Part Number
CAPACITORS			SWITCHES		
C-1, 2, 3	Trimmer, Compression Mica, 3 Section; 2-25 mmf	044-200129	S-1A-B-C-D	Rotary Wafer; Band Selector	060-300861
C-4	20-120 mmf; Ceramic Trimmer	044-100424	S-2, 5	SPDT Slide; Speaker-Phones and AM-CW	060-100477
C-5	2700 mmf, 5%, 500V; Mica	470-412272	S-3	On-Off; Part of R-9	-----
C-6A-B-C-D	Tuning, General Coverage; Inc. Bracket and Pulley	048-300372	S-4	SPST Slide; Receiver-Standby	060-100476
C-6A-B-C-D	Tuning, Band Spread; Inc. Bracket and Pulley	048-000410	SOCKETS AND CONNECTORS		
C-7, 12, 16	220 mmf, 10%, 500V; Mica	470-213221	TS-1	Terminal Strip, Antenna	060-100671
C-8, 1B	.02 mfd, 600V; Tubular Paper	499-033205	TS-2	Twin Jack Strip, Phones	060-100771
C-9	.05 mfd, 200V; Tubular Paper	499-013505		Socket, Dial Lamp (Inc. Leads)	060-100122
C-10	.003 mfd, 500V; Tubular Paper	499-034302		Socket, 7-Pin Miniature	060-100306
C-11A-B-C	Printed Circuit Plate, .005 mfd, 220 mmf, .003 mfd	047-100681	TUBES AND DIAL LAMP		
C-13	.01 mfd, 600V; Tubular Paper	499-033103	V-1	12BE6; Converter	090-900040
C-14A-B-C-D	Filter, 4 Section; 20 mfd @ 25V, 60-40-40 mfd @ 150V	045-200091	V-2	12BA6; IF Amplifier and BFO	090-900039
C-17	425-625 mmf; Mica Trimmer	044-100349	V-3	12AV6; Detector and Audio Amplifier	090-901187
C-18	4700 mmf, 5%, 500V; Mica	470-412472	V-4	50C5; Audio Output	090-900541
C-19	3000 mmf, 5%, 500V; Mica	470-412302	V-5	35W4; Rectifier	090-900384
C-20, 21, 22	Trimmer, Compression Mica, 4 Section; 6.5-70 mmf, 3.5-30 mmf, 2.5-16 mmf, 3.5-30 mmf	044-200159	LM-1	Lamp, Dial Type 447	039-100004
C-24	.05 mfd, 600V; Tubular Paper	499-033505	MISCELLANEOUS		
C-25, 26, 31	.005 mfd, 450V; Ceramic Disc	047-100186		Back, Cabinet	032-400754
C-27	.022 mfd, 600V; Molded Tubular Paper	499-034223		Background, Dial (Paper)	032-300749
C-28	.01 mfd, 450V; Ceramic Disc	047-000224		Bracket, Dial Plate Mtg.	067-200189
C-32	.01 mfd, 200V; Tubular Paper	499-013103		Bracket-Left (Glass Retaining)	067-200383
*RESISTORS				Bracket-Right (Glass Retaining)	067-200336
R-1	10K ohms	451-252103		Bracket, Lid, Pulley, and Dial Lamp	067-200191
R-2, 5	2.3 megohms	451-252225		Bracket, Pulley Mtg.	067-200190
R-3	25K ohms	451-252223		Bracket, Switch	067-200192
R-4	270 ohms	451-252271		Bushing, Tuning and Band Spread Shaft	077-201684
R-6	350 ohms	451-252351		Cabinet	066-401784
R-7	47K ohms	451-252473		Clip, Dial Mtg.	076-100646
R-8, 12, 21, 23	470K ohms	451-252474		Clip, IF Mtg.	076-100385
R-9	2 megohms, Variable; Volume Control (Inc. On-Off Switch-S-3)	025-201479		Clip, Dial Lamp Mtg.	076-100689
R-10	10 megohms	451-252106		Cover, Cabinet Bottom	032-300501
R-11	220K ohms	451-252224		Dial Cord (Specify Length)	038-100026
R-13	100 ohms	451-252101		Foot, Mtg.	016-200683
R-14, 15, 17	15 ohms	451-252150		Gasket, Rubber	016-200929
R-16, 18	22 ohms	451-252220		Glass, Dial Window	022-200570
R-19	220 ohms, 1 watt	451-252221		Knob, Band Selector	015-201259
R-20	1K ohm	451-252103		Knob, Band Spread, Off-Volume, or Main Tuning	015-201258
R-23, 25	470 ohms	451-252471		Line Cord and Plug	067-100076
*All Resistors 10%, 1/2 watt carbon type unless otherwise specified.				Line Cord Lock (Male Section)	076-100397-01
COILS AND TRANSFORMERS				Line Cord Lock (Female Section)	076-100397-02
**L-1, C-1, 2, 3	Coil and Trimmer Assembly, Antenna; Bands 1, 2, and 3	051-302132		Pointer, Band Spread	082-200350
L-2	Coil, Antenna; Band 4	051-201015		Pointer, Main Tuning	082-200349
**L-3, C-20, 21, 22, 23	Coil and Trimmer Assembly, Oscillator; All Bands	051-302133		Pulley, 3.125" od	028-200256
L-4	Choke, RF; 540 oh	063-100107		Pulley, 2.875" od	028-200257
T-1	Transformer, 1st IF	050-300451		Shield, Tube	060-100232
T-2	Transformer, 2nd IF	050-300452		Shield, Dial Lamp	008-101249
T-3	Transformer, Audio Output	050-300457		Speaker, 8" PM, 3.2 ohm v. c.	065-300030

**The Trimmer Capacitor Assemblies are also available separately. See "CAPACITORS".

**ERRATA SHEET
FOR
MODEL S-38E**

After the service data for your S-38E receiver was published, electrical modifications were made for improved performance. The following amendments to the schematic and service parts list should be made at this time:

1. Correct the high side of C-30 (wire gimmick) to connect pins 5 and 6 of 12AV6. Delete C-30 connection to the plate of 12BA6.
2. Add C-33, a .01 mfd, 450V. ceramic disc capacitor, part number 047-000224. C-33 is wired from pin 6 of 50C5 to chassis.
3. Correct filament string by interchanging pins 4 and 3 of V3 (12AV6). Pin 3 of V3 is wired to chassis, whereas, pin 4 is wired in series with pin 4 of V1 (12BE6).
4. On schematic under the title VOLTAGES, correct item 1 to read, "All voltages are measured between tube socket terminals and B- (pin 3 of 12AV6) with antenna terminals shorted, AM/CW switch at AM, and Receive/Standby switch at Receive."

Pack with Service Data
#094-901866
Form #094-901875